

- Case No. 174-00-56120
- SA [redacted], Sketcher
- Sketch 1
- Overall East-half of block:

- Major Case 117 BK BOMU
- 109 S. 2nd
- Herington, KS
- 04/01/2005

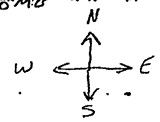

b6
b7c

Day St.

NTS

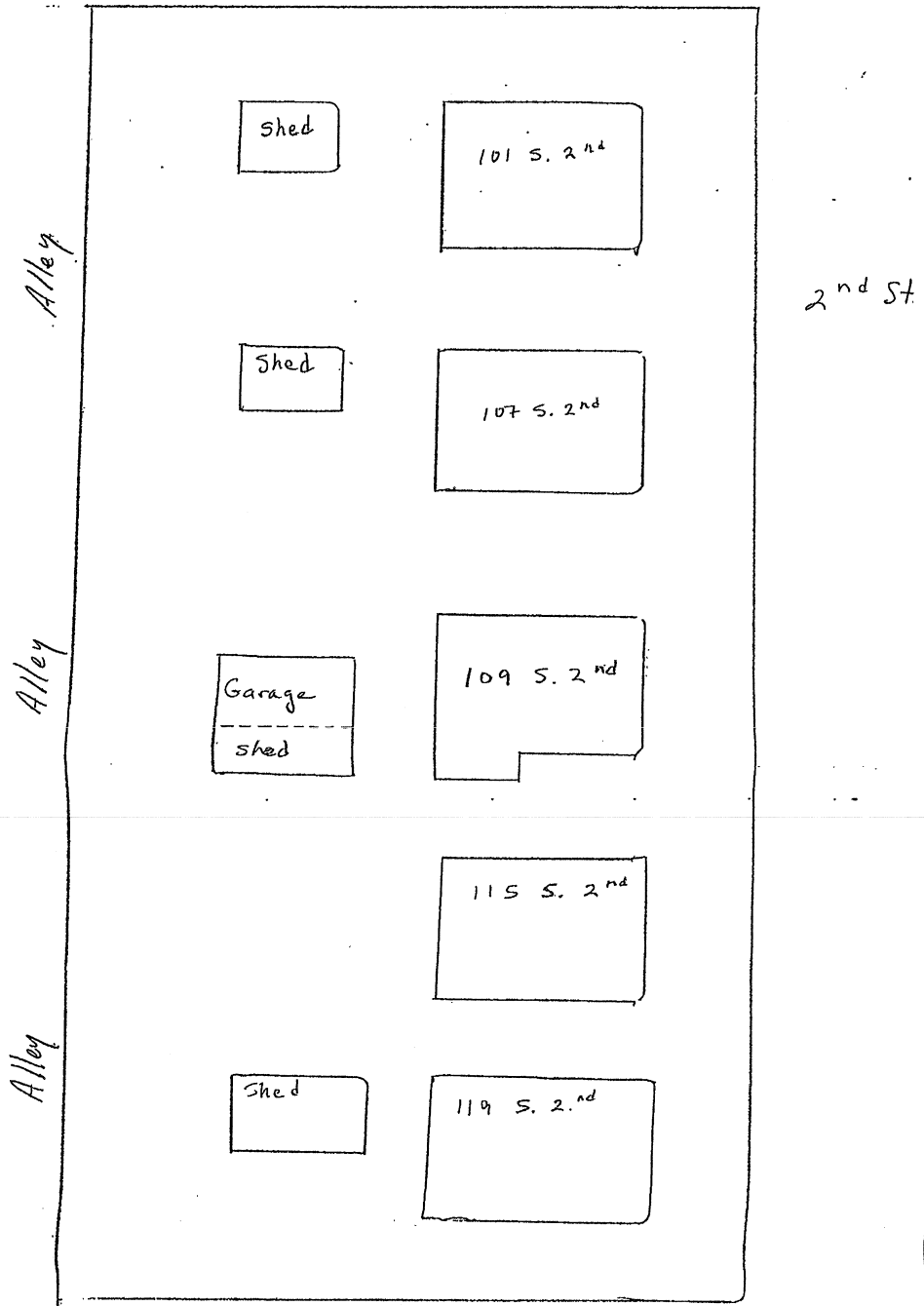

McClaren St.

- Case No. 174 - DC - 56120 - Major Case No. 117 DK/Bom B
- SA [redacted] Sketcher - 109 S. 2nd St.
- Herington, KS
- 04/01/2005

- Sketch 2
- Exterior 109 S. 2nd St.

b6
b7C

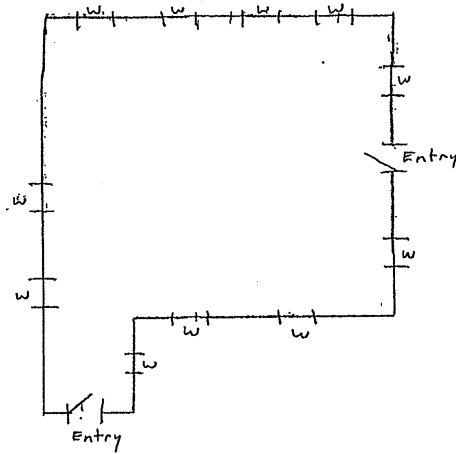
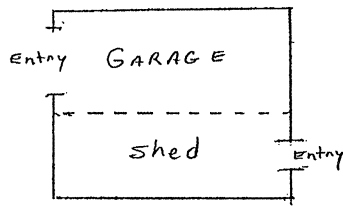
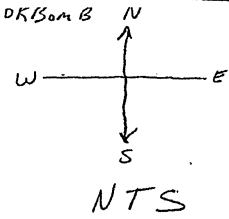

- Case No. 174 - 0C - 56120

- Major Case No. 117 OK BOMB

- SA [redacted]

- 109 S. 2nd St.

- Herington, KS

- 04/01/2005

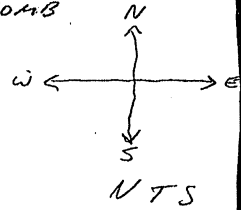

- sketch 3
- Main Floor

b6
b7c

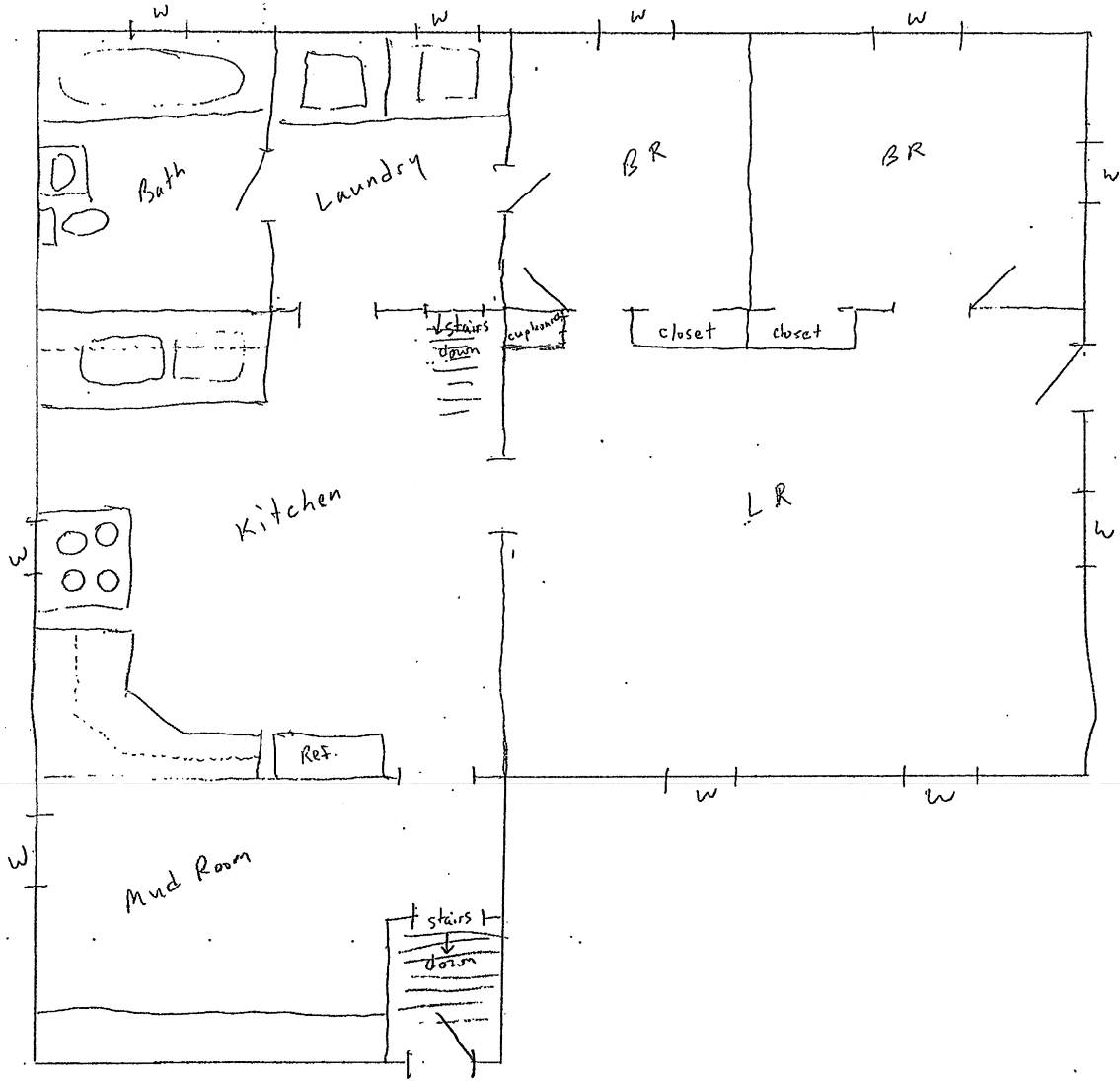

- Case No. 174-OC-56120 - Major Case No. 117 OKBOMB
- SA [redacted] - 109 S. 2nd St.
- Herington, KS
- 04/01/2005

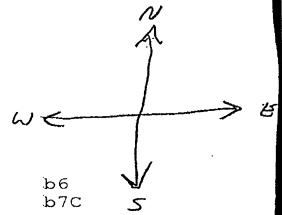

- sketch 4
- Basement and crawl space

NTS

